

Data Sheet

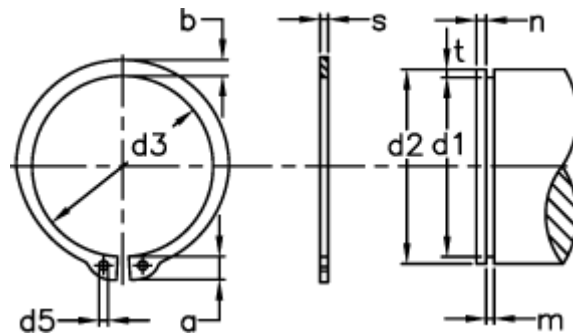

Article number: 0109095
 Description: Retaining ring AS 95x4.0
 Spring steel
 Note: Fitted with ZGA pliers

Measures



a max	= 10.2	Description	= AS 95	s	= 4.00
AN mm ²	= 513.0	FN kN	= 85.50	t	= 1.75
B	= 1.78	FRg kN	= 52.0	tol	= -0.35
b	= 8.6	FR kN	= 378.0	tol	= -0.10
d1	= 91.5	g	= 3.5	tol	= +0,54 -1,30
d2	= 95	m min	= 4.15	Tong	= ZGA-4
d3	= 89.5	n abl x 1000	= 5	Weight kg/1000	= 61.20
d5 min	= 3.5	Nominal drive	= 5.3		